

**1 PLAN PARTER**  
1 : 50

INDICATIV	DESCRIERE	CULOARE
RR	- Incalzire Radiatoare Retur	<span style="color: blue;">—</span>
RT	- Incalzire Radiatoare Tur	<span style="color: red;">—</span>

INDICATIV	DESCRIERE	TIP	CANT	Ventil
R	RADIATOR OTEL PANOU	11 600 x 400	3	1/2"
R	RADIATOR OTEL PANOU	22 600 x 400	6	1/2"
R	RADIATOR OTEL PANOU	22 600 x 500	7	1/2"
R	RADIATOR OTEL PANOU	22 600 x 600	1	1/2"
R	RADIATOR OTEL PANOU	22 600 x 700	1	1/2"
R	RADIATOR OTEL PANOU	22 600 x 800	4	1/2"
R	RADIATOR OTEL PANOU	22 600 x 900	2	1/2"
R	RADIATOR OTEL PANOU	22 600 x 1000	16	1/2"
R	RADIATOR OTEL PANOU	22 600 x 1100	8	1/2"
R	RADIATOR OTEL PANOU	22 600 x 1200	8	1/2"
R	RADIATOR OTEL PANOU	22 600 x 1800	7	1/2"

VERIFICATOR	NUME	SEMNATURA	SERIE
PROIECTANT GENERAL SI DE SPECIALIZARE			
SPECIFICATIE	NUME	SEMNATURA	SCARA
SEF PROIECT	dr. ing. Luciu Razvan Silviu		1 : 50
PROIECTANT	ing. Tanasuca Cosmin-Ionut		DATA
DESENAT	ing. Tanasuca Cosmin-Ionut		2021

PROIECTANT GENERAL SI DE SPECIALIZARE	BENEFICIAR	Pr. Nr.
S.C. AIR-PROJECTS S.R.L. J2227102/2013 CF: 30903328	COMUNA SABAOANI, JUD. NEAMT	0307/2021
TITULUL PROIECTULUI:	SISTEM DE INCALZIRE CENTRALA CORP C LICEUL TEORETIC "VASILE ALECSANDRI" SABAOANI	FAZA:
ADRESA:	Str. Progresului, Comuna Sabaoani, jud. Neamt	PTH-DE
TITULUL PLANSAI:	PLAN PARTER - INSTALATII TERMICE	Bl. Nr.
		T1

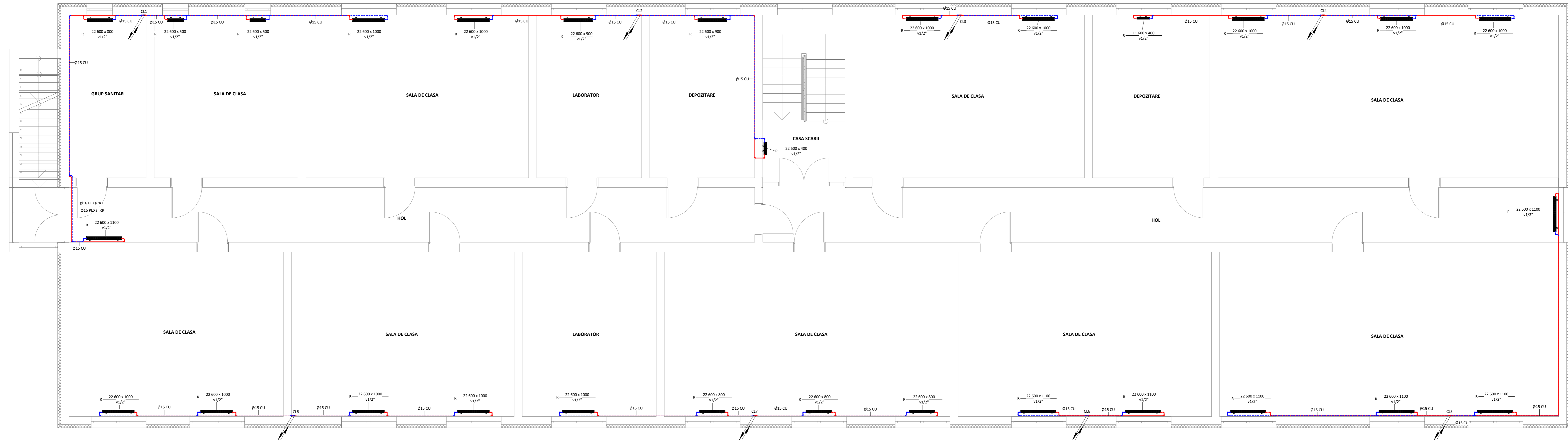

1 PLAN ETAJ  
1 : 50

DESCRIERE SISTEME		
INDICATIV	DESCRIERE	CULOARE
RR	- Incalzire Radiatoare Retur	<span style="color: blue;">■</span>
RT	- Incalzire Radiatoare Tur	<span style="color: red;">■</span>

DESCRIERE RADIATOARE				
INDICATIV	DESCRIERE	TIP	CANT	Ventil
R	RADIATOR OTEL PANOU	11 600 x 400	3	1/2"
R	RADIATOR OTEL PANOU	22 600 x 400	6	1/2"
R	RADIATOR OTEL PANOU	22 600 x 500	7	1/2"
R	RADIATOR OTEL PANOU	22 600 x 600	1	1/2"
R	RADIATOR OTEL PANOU	22 600 x 700	1	1/2"
R	RADIATOR OTEL PANOU	22 600 x 800	4	1/2"
R	RADIATOR OTEL PANOU	22 600 x 900	2	1/2"
R	RADIATOR OTEL PANOU	22 600 x 1000	16	1/2"
R	RADIATOR OTEL PANOU	22 600 x 1100	8	1/2"
R	RADIATOR OTEL PANOU	22 600 x 1200	8	1/2"
R	RADIATOR OTEL PANOU	22 600 x 1800	7	1/2"

VERIFICATOR	NUME	SEMNATURA	CEBINTA
PROIECTANT GENERAL SI DE SPECIALITATE			
 <b>S.C. AIR-PROJECTS S.R.L.</b> <small>J2227102/2013 CP: 32003328</small>			
BENEFICIAR:		COMUNA SABAOANI, JUD. NEAMT	
TITULUL PROIECTULUI:		SISTEM DE INCALZIRE CENTRALA CORP C LICEUL TEORETIC "VASILE ALECSANDRI" SABAOANI	
SCARA:		1 : 50	
ADRESA:		Str. Progresului, Comuna Sabaoani, jud. Neamt	
DATA:		2021	
TITULUL PLANULUI:		PLAN ETAJ - INSTALATI TERMICE	
Pr. nr.	0307/2021	FAZA:	PTH-DE
		Dr. nr.	T2

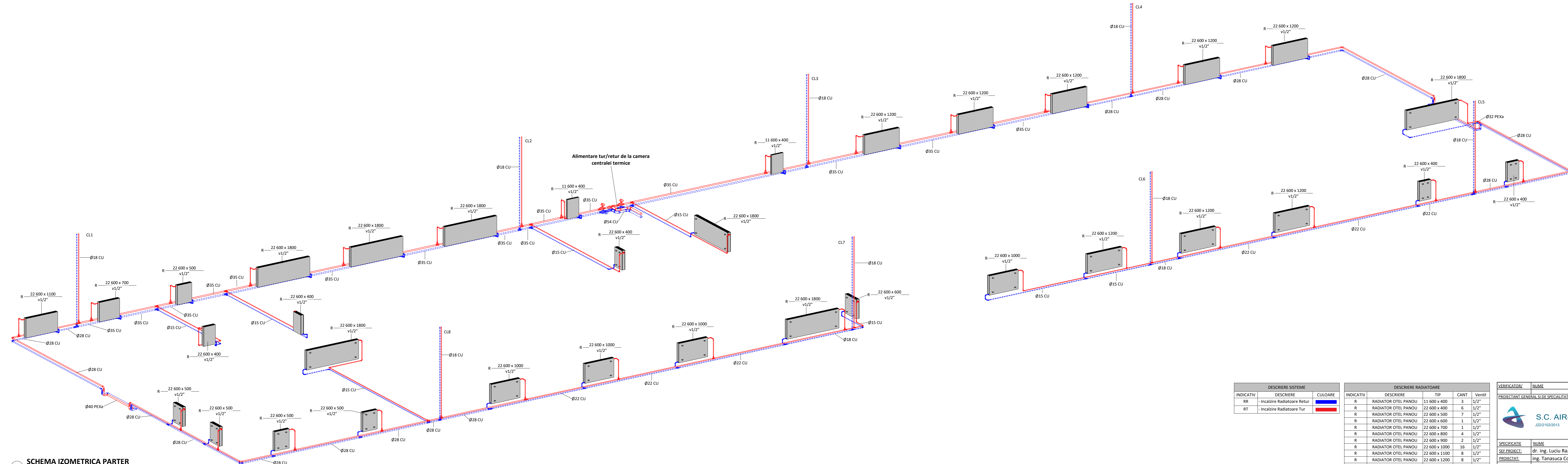

1 SCHEMA IZOMETRICA PARTER

DESCRIERE SISTEME		
INDICATIV	DESCRIERE	CULOARE
RR	- Incalzire Radiatoare Retur	<span style="color: blue;">■</span>
RT	- Incalzire Radiatoare Tur	<span style="color: red;">■</span>

DESCRIERE RADIATOARE				
INDICATIV	DESCRIERE	TIP	CANT	Ventil
R	RADIATOR OTEL PANOU	11 600 x 400	3	1/2"
R	RADIATOR OTEL PANOU	22 600 x 400	6	1/2"
R	RADIATOR OTEL PANOU	22 600 x 500	7	1/2"
R	RADIATOR OTEL PANOU	22 600 x 600	1	1/2"
R	RADIATOR OTEL PANOU	22 600 x 700	1	1/2"
R	RADIATOR OTEL PANOU	22 600 x 800	4	1/2"
R	RADIATOR OTEL PANOU	22 600 x 900	2	1/2"
R	RADIATOR OTEL PANOU	22 600 x 1000	16	1/2"
R	RADIATOR OTEL PANOU	22 600 x 1100	8	1/2"
R	RADIATOR OTEL PANOU	22 600 x 1200	8	1/2"
R	RADIATOR OTEL PANOU	22 600 x 1800	7	1/2"

VERIFICATOR/	NUME	SEMNATURA	CERINTA		
PROIECTANT GENERAL SI DE SPECIALITATE:				BENEFICIAR:	
 S.C. AIR-PROJECTS S.R.L. J22/2102/2013 CIF: 32603328				COMUNA SABAOANI, JUD. NEAMT	
				TITUL PROIECTULUI: SISTEM DE INCALZIRE CENTRALA CORP C LICEUL TEORETIC "VASILE ALECSANDRI" SABAOANI	
SPECIFICATIE				ADRESA:	Pr. nr.
SEM NATAURA				Str. Progresului, Comuna Sabaoani, jud. Neamt	0307/2021
SCARA:				DATA:	FAZA:
dr. ing. Luciu Razvan Silviu				2021	PTH-DE
PROIECTAT:				TITUL PLANSA:	Pl. nr.
ing. Tanasuca Cosmin-Ionut				SCHEMA IZOMETRICA PARTER - INSTALATII TERMICE	T3
DESENAT:					
ing. Tanasuca Cosmin-Ionut					

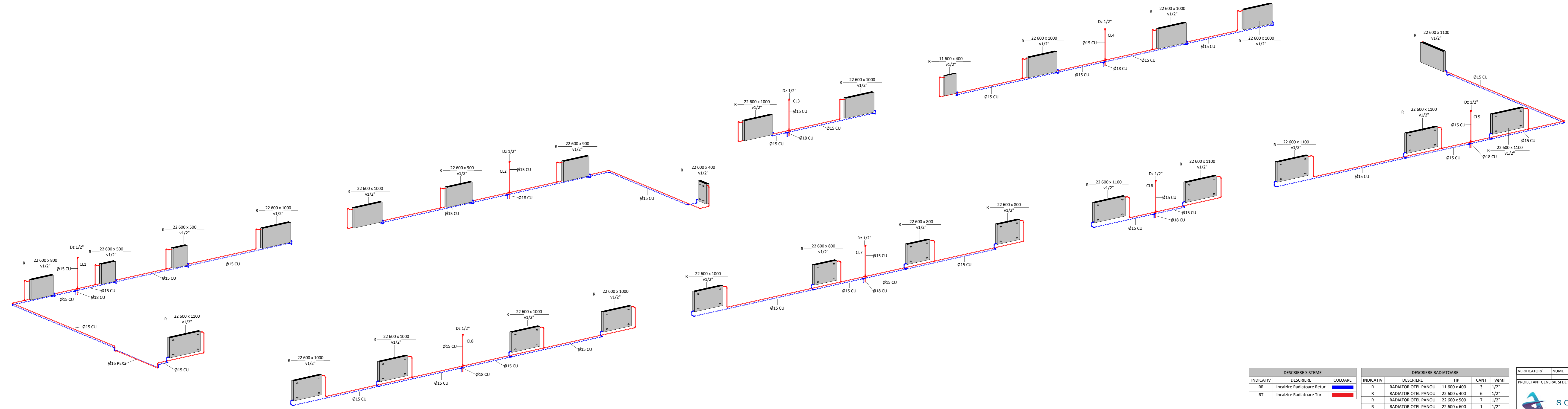

1 SCHEMA IZOMETRICA ETAJ

DESCRIERE SISTEME		
INDICATIV	DESCRIERE	CULOARE
RR	- Incalzire Radiatoare Retur	<span style="color: blue;">—</span>
RT	- Incalzire Radiatoare Tur	<span style="color: red;">—</span>

DESCRIERE RADIATOARE				
INDICATIV	DESCRIERE	TIP	CANT	Ventil
R	RADIATOR OTEL PANOU	11 600 x 400	3	1/2"
R	RADIATOR OTEL PANOU	22 600 x 400	6	1/2"
R	RADIATOR OTEL PANOU	22 600 x 500	7	1/2"
R	RADIATOR OTEL PANOU	22 600 x 600	1	1/2"
R	RADIATOR OTEL PANOU	22 600 x 700	1	1/2"
R	RADIATOR OTEL PANOU	22 600 x 800	4	1/2"
R	RADIATOR OTEL PANOU	22 600 x 900	2	1/2"
R	RADIATOR OTEL PANOU	22 600 x 1000	16	1/2"
R	RADIATOR OTEL PANOU	22 600 x 1100	8	1/2"
R	RADIATOR OTEL PANOU	22 600 x 1200	8	1/2"
R	RADIATOR OTEL PANOU	22 600 x 1800	7	1/2"

VERIFICATOR/	NUME	SEMNRATURA	CERINTA		
PROIECTANT GENERAL SI DE SPECIALITATE:				BENEFICIAR:	
 S.C. AIR-PROJECTS S.R.L. J22/2102/2013 CIF: 32603328				COMUNA SABAOANI, JUD. NEAMT	
				TITULUL PROIECTULUI: SISTEM DE INCALZIRE CENTRALA CORP C LICEUL TEORETIC "VASILE ALECSANDRI" SABAOANI	
SPECIFICATIE				NUME	SEMNRATURA
SEF PROIECT:				dr. ing. Luciu Razvan Silviu	SCARA:
PROIECTAT:				ing. Tanasuca Cosmin-Ionut	DATA:
DESENAT:				ing. Tanasuca Cosmin-Ionut	2021
				ADRESA:	Str. Progresului, Comuna Sabaoani, jud. Neamt
				TITULUL PLANSA:	SCHEMA IZOMETRICA ETAJ - INSTALATII TERMICE
				Pr. nr.	0307/2021
				FAZA:	PTH-DE
				Pl. nr.	T4

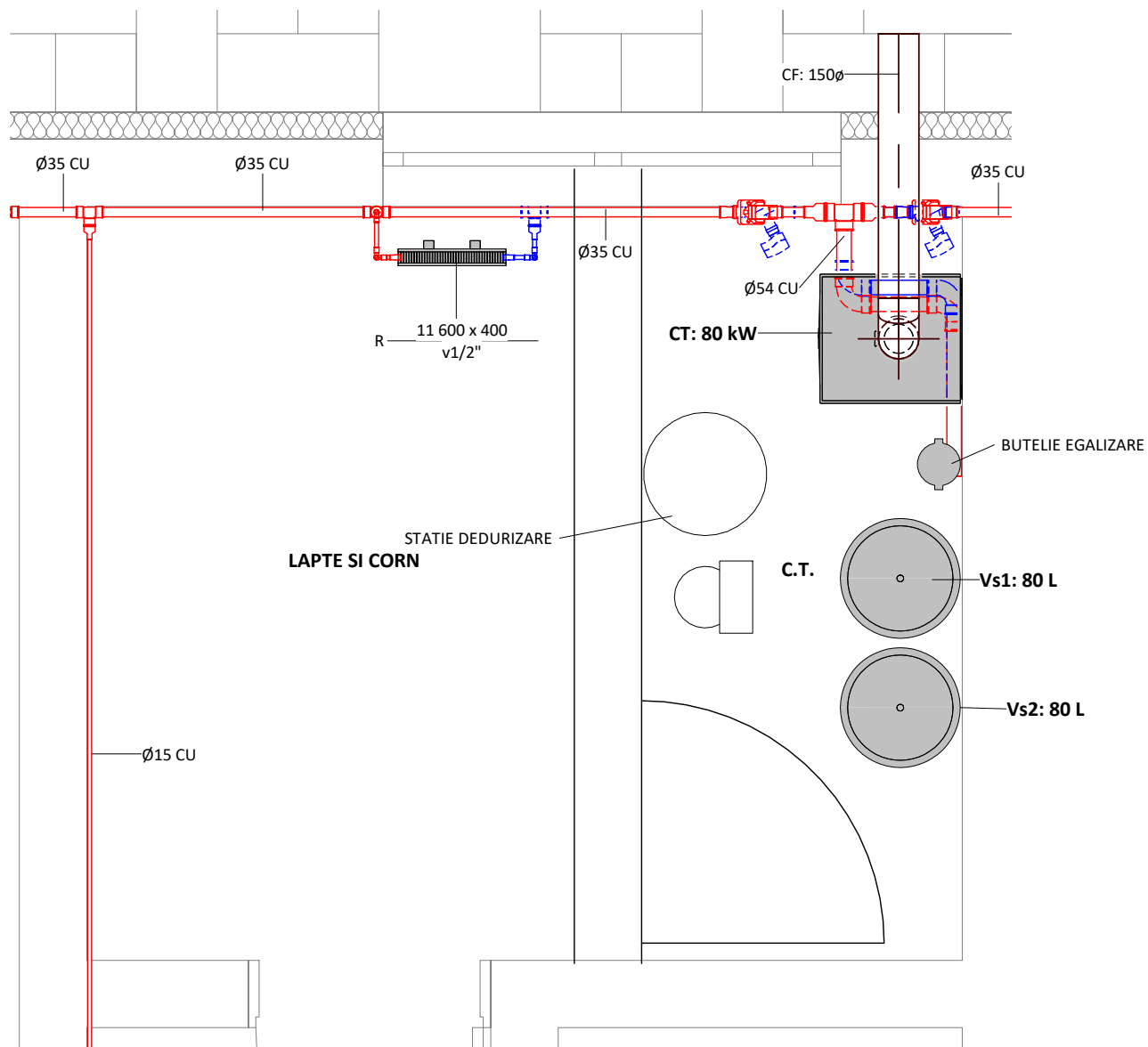

# 1 PLAN CENTRALA TERMICA

1 : 25

VERIFICATOR/	NUME	SEMNATURA	CERINTA		
<b>PROIECTANT GENERAL SI DE SPECIALITATE:</b>  <b>S.C. AIR-PROJECTS S.R.L.</b> J22/2102/2013      CIF: 32603328				<b>BENEFICIAR:</b> COMUNA SABAOANI, JUD. NEAMT Pr. nr. 0307/2021	
<b>SPECIFICATIE</b> dr. ing. Luciu Razvan Silviu				<b>TITLUL PROIECTULUI:</b> SISTEM DE INCALZIRE CENTRALA CORP C LICEUL TEORETIC "VASILE ALECSANDRI" SABAOANI FAZA: PTH+DE	
<b>SEF PROIECT:</b> ing. Tanasuca Cosmin-Ionut				<b>ADRESA:</b> Str. Progresului, Comuna Sabaoani, jud. Neamt	
<b>PROIECTAT:</b> ing. Tanasuca Cosmin-Ionut				<b>TITLU PLANSA:</b> <b>PLAN CENTRALA TERMICA - POZITIONARE ECHIPAMENTE TERMICE</b>	
<b>DESENIAT:</b> ing. Tanasuca Cosmin-Ionut				DATA: 2021 Pl. nr. T5	

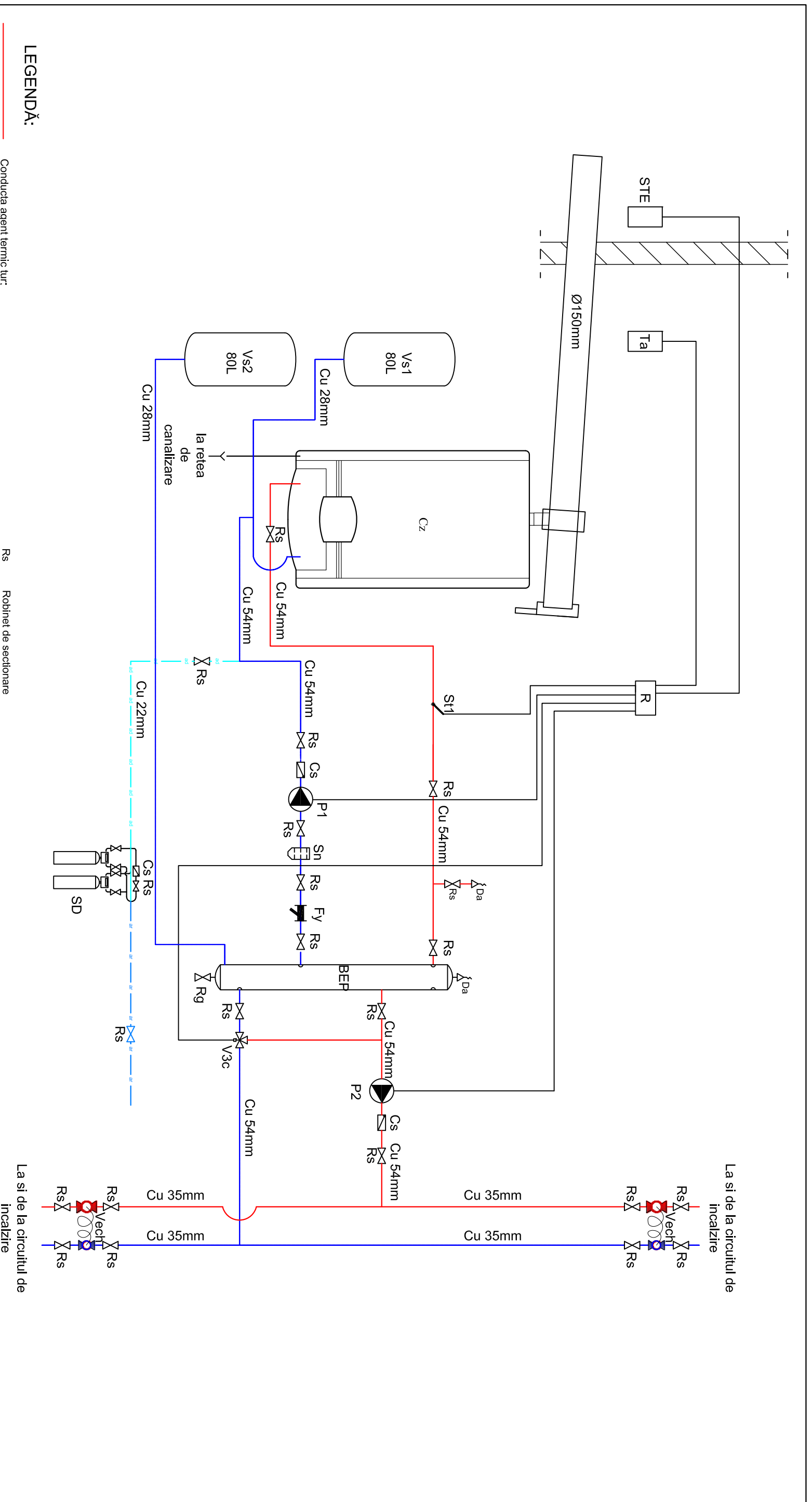

**LEGENDĂ:**

- Conductua agent termic tur;
- Conductua agent termic retur;
- Conductua apa rece;
- Conductua apa deduzitata;
- Circuit de automatizare;
- Cz Cazan combustibil gazos in condensare avand puterea de 80 kW;
- Vs Vas de expansiune a instalatiei de incalzire de 200l;
- BEP Butelie de egalizare a presiunii;
- P1 Pompa de circulatie a agentului termic intre cazan si BEP, avand urmatoarele caracteristici:  
Q= 3,39 mc/h; H= 5,5 mCA;
- P2 Pompa de circulatie a agentului termic intre radiatoare, avand urmatoarele caracteristici:  
Q= 3,39 mc/h; H= 6,5 mCA;
- SD Statie de deduzitare 2,4 mc/h
- Rs Robinet de sectionare
- SS Supapa de siguranta;
- Cs Clapet de sens;
- Rg Robinet golire;
- Da Dezaerator automat;
- M Manometru
- T Termometru
- St Sonda de temperatura
- Fy Filtru mecanic de impuritati
- Sn Separator de namol
- TA Termostat de ambient
- STE Senzor de temperatura exterioara
- R Regulator electronic
- V3c Vana cu 3 cai cu servomotor;
- Vech Vana de echilibrare hidraulica;

VERIFICATOR/	NUME	SEMNATURA	CERINTA
PROIECTANT GENERAL SI DE SPECIALITATE:	Verificator		
BENEFICIAR:	COMUNA SABAONI, JUD. NEAMT		
TITUL PROIECTULUI:	SISTEM DE INCALZIRE CENTRALA CORP C LICEUL TEORETIC "VASILE ALECSANDRI" SABAONI		
ADRESA:	Str. Progresului, Comuna Sabaoni, jud. Neamt		
PROIECTANT SPECIALITATE:	NUME	SEMNATURA	SCARA:
SEF PROIECT:	Dr. Ing. Luciu Razvan Silviu		%
PROIECTANT:	Ing. Tanasuca Cosmin-Ionut		
DESEMNAT:	Ing. Tanasuca Cosmin-Ionut		DATA: 2021
TITUL PLANSA:	SCHEMA TERMOENERGETICA CT - INSTALATIILE TERMICE		
PL. NR.	DTAC		
PL. NR.	T6		



**S.C. AIR - PROJECTS S.R.L.**  
122/2102/2013  
CFR: 32803228

PROIECTANT SPECIALITATE:

CFR: 32803228